

Condor

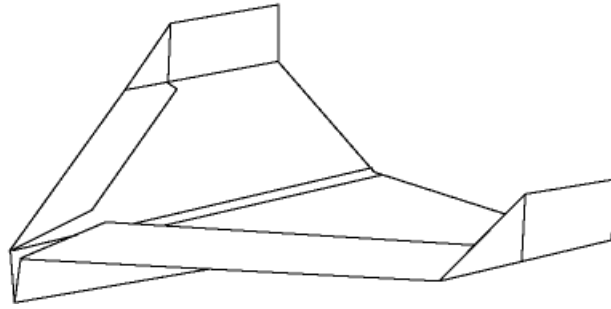

This plane produces tremendous lift at low speed, giving it a very low glide slope. It is an excellent indoor flier and will coast across the room on slow, smooth glides.

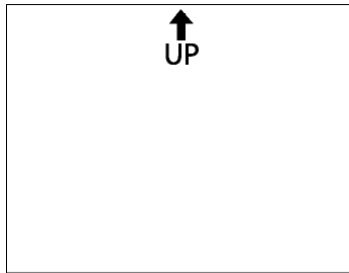

Orient the template so that the “UP” arrow is at the top of the page. Then flip the paper over so that none of the fold lines are showing.

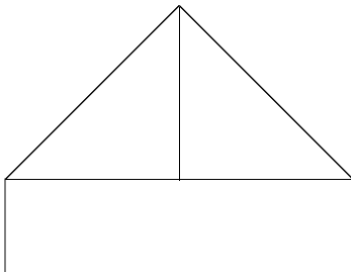

Fold the top left corner down toward you until fold line 1 becomes visible. Crease along the dotted line and repeat with the top right corner.

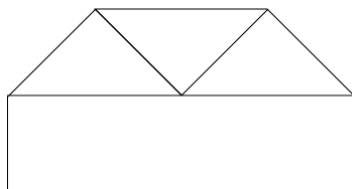

Fold the nose down until fold line 2 becomes visible and crease along the dotted line.

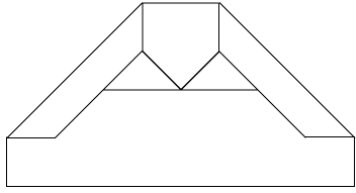

Fold the outside wing edges in and crease along fold lines 3.

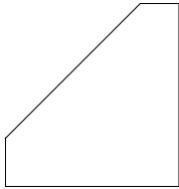

Fold the right half of the plane over the left half and crease along fold line 4 so that the outside edges of the wings line up.

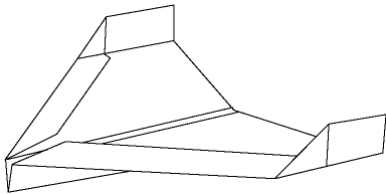

Fold the wings down along fold lines 5 and the winglets up along fold lines 6. Add wing dihedral by tilting the wings up slightly away from the fuselage. The wings will have a slight "V" shape when viewed from the front. Add elevator slits along the back edge of the wings to adjust the flight if necessary. You are ready to fly!

CUT HERE

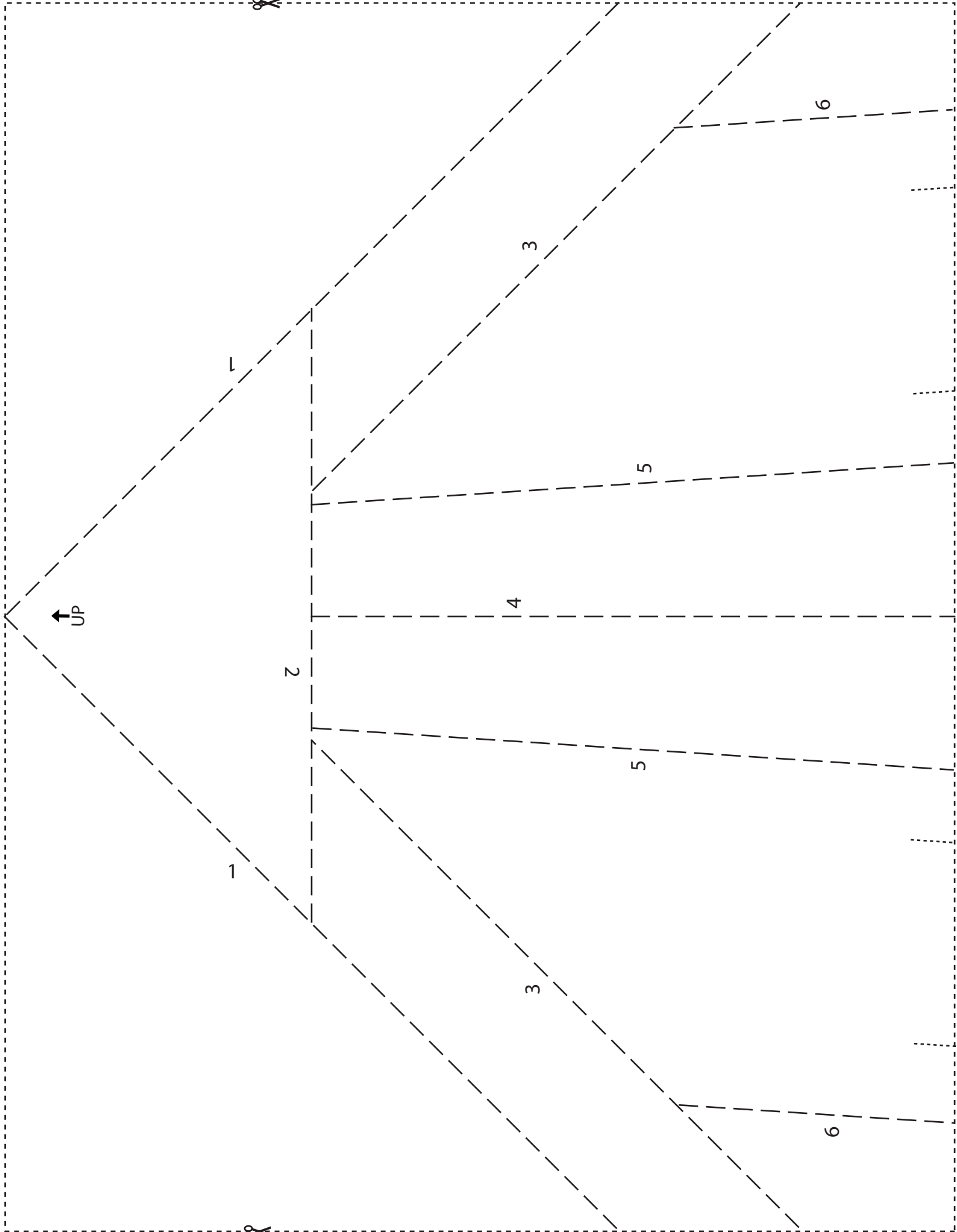

CUT HERE

